

Installation & Maintenance of V-Belt Drives



 **TB Wood's**
Incorporated

An Altra Industrial Motion Company

Quality Products and the Support to Back Them Up – Wood's



V-Belt sheaves of close grain, high-tensile cast iron are machined to provide safe, vibration-free operation at speeds up to 6500 FPM. Made to order sheaves of ductile iron material can be provided for speeds up to 10,000 FPM. V-Belt drives are only the beginning of what Wood's can do.

Wood's offers a complete line of high capacity synchronous drives. The RPP-Plus system offers a higher horsepower capacity drive at the cost of the competition's standard rated product. Wood's also offers the aramid fiber QT Powerchain drive in 8M and 14M pitch. The QT drive is capable of high horsepower capacity in a smaller package. Both QT and RPP sprockets offer metric/inch drilling for applications which require a totally metric drive system.



Wood's has many different ways of offering variable speed for customer applications. The most basic way is through the use of one of our many belted variable speed systems. Wood's also offers many different options in the line of electronic inverters and electronic speed controls. One of the most unique ways of varying speed, however, is our HSV/HSVA hydrostatic systems. The HSV system is ideal for harsh, dirty, or explosive proof environments.

Wood's Elastomeric coupling line offers something for every application. Wood's Jaw couplings offer a full compliment of spider materials and bore option. Our Sure-Flex line offers the 4-way flexing action, and many different flange and sleeve options to meet your needs. The Dura-Flex coupling is designed and patented with improvements over other similar type coupling that provide for the maximum possible service life.



Wood's line of Steel couplings offers both gear and disc coupling options. Wood's Form-Flex disc couplings offer zero-backlash and eliminate the need for lubrication. Our gear couplings are available in all the standard, spacer, and special options common to the industry. In both disc and gear lines we welcome the challenge of the "special" coupling.

Contents

1	Inspection and Maintenance	
	Inspect While Running	1
	Inspect Sheaves Often	1
	Use Belt and Sheave Gages	2
	Check Belt Fit	2
	Keep Belts Clean	3
	Use Belt Guards	3
	Check for Hot Bearings	3
	Maintain Proper Belt Tension	3
2	Belt Selection	
	Selecting Correct Belts	4
	ORS Construction	5
	Explosive Atmospheres	5
	Proper Belt Storage	6
3	Safety Tips	
	Guard Drives	7
	Safe Speed Limits	7
4	Drive Installation	
	Sheave and Bushing Installation	8
	Sheave and Bushing Removal	9
	Check Alignment	10
	Install Belts	11
	Take-Up Allowances	11
5	Tensioning the Drive	
	General Method	12
	Force Deflection Method	13
	Belt Elongation Method	16
6	Trouble Shooting V-Belts	
	How to Spot Trouble	18
	How to Diagnose Failure	19

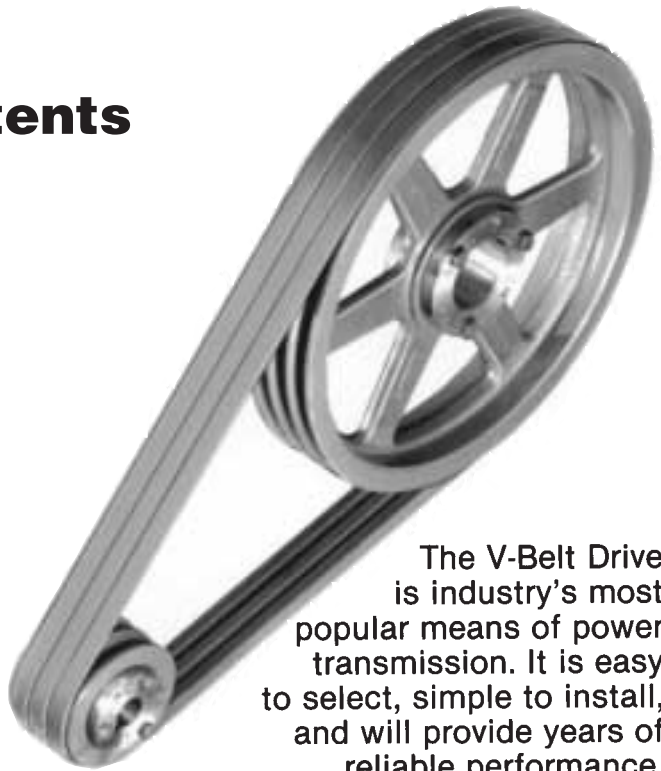

The V-Belt Drive is industry's most popular means of power transmission. It is easy to select, simple to install, and will provide years of reliable performance.

Even when misapplied, improperly installed or completely ignored, the V-Belt Drive will usually deliver some kind of performance. However, with proper installation and maintenance, many years of operating efficiency can be added to the life span of the V-Belt Drive.

It is hoped that the information contained herein will help you receive the greatest possible value from your V-belts and sheaves, will help you receive a full measure of performance from industry's dominant drive.

V-Drive Inspection and Maintenance Procedures

Well designed and properly installed V-belt drives are without question the most reliable, trouble-free means of power transmission available. In general, except for an occasional retensioning, they will run year in and year out without maintenance.

However, some do require periodic inspection and maintenance, both while the drive is running and while it is stationary.

Inspection while running

A noisy V-belt drive is like a person with a fever. Both need attention.

V-drive noise can be caused by the slapping of belts against the drive guard or other obstruction. Check for an improperly installed guard, loose belts or excessive vibration. Squealing of belts as a drive is started or while it is running is usually caused by a poorly tensioned drive and/or by a build-up of foreign material in the sheave grooves. But it can also be caused by oil or grease between the belt and the sheave groove.

If necessary, remove the belt guard and watch the drive while it is running under load. **(Caution: Observe only; stand clear of the running drive!)** Much can be learned by watching the action of the slack side of the drive. Each variation in the driven load causes a corresponding change in the tension of the slack side of the belt. During across-the-line starts or suddenly applied loads while running, the sag on the slack side of the drive will increase. If the sag under these conditions is excessive, tension should be increased.

Any vibration in a system will cause the slack side of the belts to dance up and down. Excessive vibration will also induce a vibration in the tight side of the drive. The cause of the vibration should be determined and corrected.

If a set of belts is perfectly matched, all belts will have the same amount of sag. However, perfec-

tion is a rare thing and there will usually exist some difference in sag from belt to belt. It is more important to look at the tight side of a drive to be sure that all of the belts are running tight. If one or more belts are running loose, the drive needs to be retensioned, or the belts replaced with a matched set.

The above conditions could also be caused by uneven wear of the grooves in the sheave. These should be checked with sheave groove gages.

Inspect sheaves often

Keep all sheave grooves smooth and uniform. Burrs and rough spots along the sheave rim can damage belts. Dust, oil and other foreign matter can lead to pitting and rust and should be avoided as much as possible. If sheave sidewalls are permitted to "dish out," as shown in the picture on page 2, the bottom "shoulder" ruins belts quickly by chewing off their bottom corners. Also, the belt's wedging action is reduced and it loses its gripping power.

A shiny groove bottom indicates that either the sheave, the belt or both are badly worn and the belt is bottoming in the groove.

Badly worn grooves cause one or more belts to ride lower than the rest of the belts, and the effect is the same as with mismatched belts. This is called "differential driving." The belts riding high in the grooves travel faster than the belts riding low. In a drive under proper tension, a sure sign of differential driving is when one or several belts on the tight side are slack.

Check alignment of drive. Sheaves that are not aligned properly cause excessive belt and sheave wear. When the shafts are not parallel, belts on one side are drawn tighter and pull more than their share of the load. These overloaded belts wear out faster, reducing the service life of the entire set. If the misalignment is between the sheaves themselves, belts will enter and leave the



TB Wood's

grooves at an angle, causing excessive cover and sheave wear and premature failure. See page 10 for complete information on drive alignment.

Sheave grooves must be
like this not this

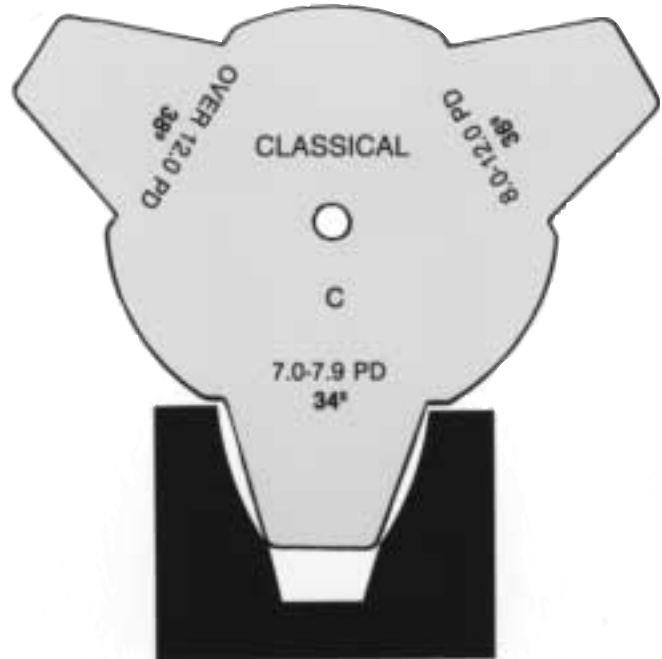
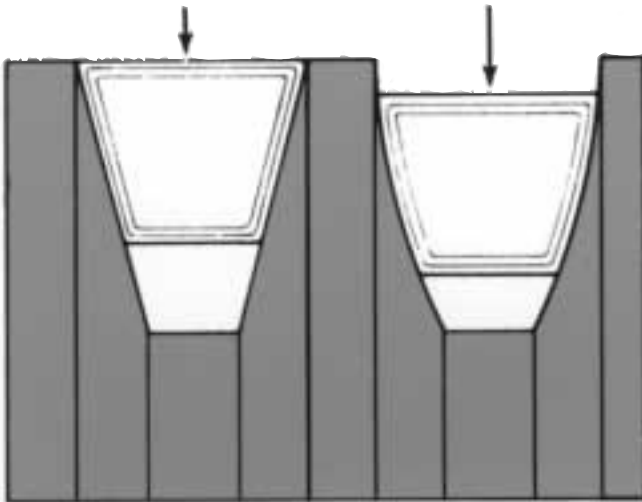

Groove gage.

Belt and sheave gages

Belt and sheave groove gage sets are available from your Wood's distributor.

You can use them to determine the proper belt section by trying the old belt in the various gages until a proper fit is obtained. The cross section of the Classical or Narrow belt can be read from the gage.

To check sheave grooves for wear, simply select the proper gage and template for the sheave diameter; then insert the gage in the groove until the rim of the gage butts against the outside diameter of the sheave flange. Worn grooves will show up as illustrated below. If more than 1/32 inch of wear can be seen, poor V-belt life may be expected.

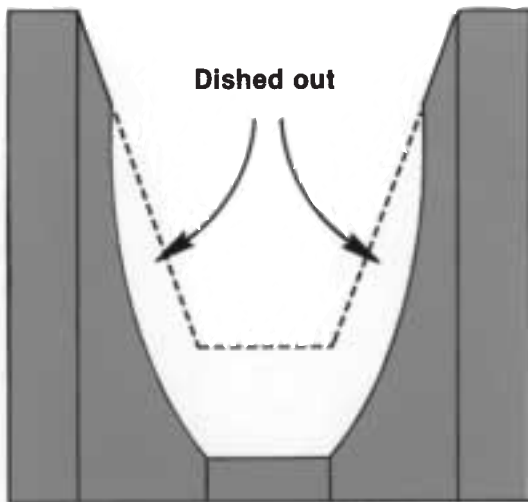

Check belt fit

Classical V-belts should ride in standard sheave grooves so that the top surface of the belt is just above the highest point of the sheave. In A-B combination grooves, an A section belt will ride slightly low in the groove, while a B belt will be in the normal position. In special deep groove sheaves, belts will ride below the top of the sheave.

Narrow belts are purposely designed so that the top of the belt will ride above the O.D. of the sheave. The tensile cords are located in the belt so that they ride almost at the O.D. of the sheave. This simplifies sheave identification and drive calculations.

No matter which V-belt section the sheave is grooved for, the belts should never be allowed to

bottom in the groove. This will cause the belt to lose its wedging action, to slip and/or burn. Sheaves worn to the point where they allow a belt to bottom should be replaced immediately.

Keep belts clean

Dirt and grease reduce belt life. Belts should be wiped with a dry cloth occasionally to remove any build-up of foreign material. If the belts have been splattered with grease and/or oil, clean them with methyl chloroform or soap and water. Inflammable cleaners such as gasoline are to be avoided as a matter of safety.

Although all Wood's V-belts are of oil resistant construction, an occasional cleaning will help to prolong their life.

Under no circumstances is the use of belt dressing recommended on a V-belt. The remedial effect is only temporary. It is much better to keep the belts and grooves of the drive clean.

Use belt guards

Belt guards protect personnel and the drive itself. They should be definitely used in abrasive atmospheres to protect the drive from sand, metal chips and other foreign matter. But they should be ventilated to avoid excessive heat.

Check them periodically for damage and for loose or missing mounting bolts. These could cause the belts to come in contact with the guard and cause failure.

Guards alone will generally protect belts from abrasion. But where abrasive materials are common — in rock processing machinery, grinders, foundries, etc. — drives should be inspected frequently for excessive belt and groove wear.

Check for hot bearings

When the drive has been stopped for inspection, check the bearings to make sure they are not running hot. If they are, it could be due to improper lubrication or improper drive tension. Hot bearings can be caused by belts that are either too

tight or too loose. Check the tension carefully using the instructions furnished.

If the belts are slipping on your drive, retension the drive. Never use belt dressing to correct slipping belts.

Maintain proper belt tension

Maintaining correct tension is the most important rule of V-belt care. It will give the belts 50% to 100% longer life.

Belts that are too loose will slip, causing excessive belt and sheave wear. V-belts that sag too much are snapped tight suddenly when the motor starts or when peak loads occur. That snapping action can actually break the belts, because the added stress is more than the belt was designed to take. This can be clearly demonstrated with a piece of string, as illustrated.

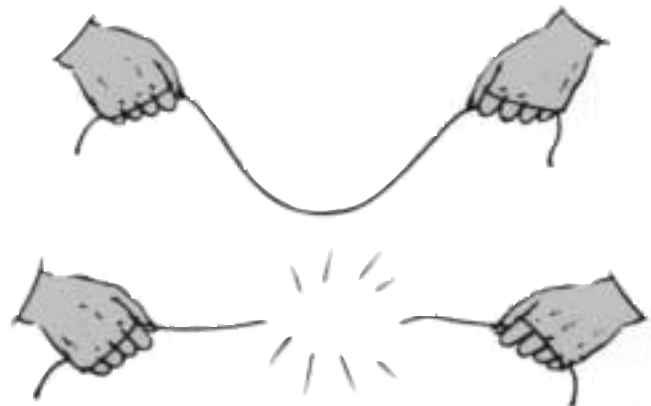

Loosely-held string snaps easily,
Taut string can stand strong pull.

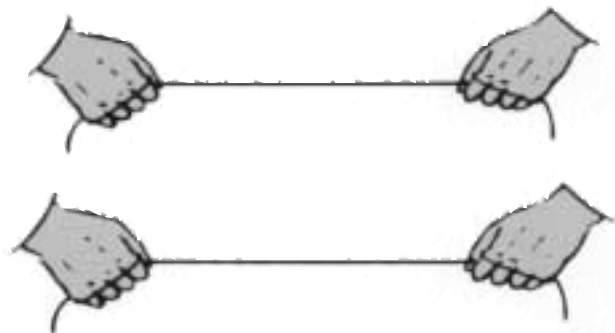

Belt Selection

Selecting the correct belts

All the work and experience that goes into designing a V-belt drive is wasted if the specified belts are not used or the number of belts is changed. Over-belting is wasteful. Under-belting is even more expensive in the long run, because overloaded belts wear out faster.

V-belts are identified for size according to industry standards. A combination of letters and numbers indicates the width across the top of the belt (often referred to as "cross section") and the belt length. Classical belts come in five widths: A, B, C, D, and E; while Narrow belts are made in three widths: 3V, 5V, and 8V. In addition, there are the Light Duty 2L, 3L, 4L, and 5L belts. If you are not sure which to use, measure the top width of the old belts carefully, or use Wood's gages described previously.

Be careful in measuring V-belts. The top widths of the B and 5V belts are very close; however, the 5V is considerably thicker, and the groove angles of the sheaves are different. Do not attempt to use these belts interchangeably. The 4L and 5L Light Duty belts are also very close in size to the A and B belts. But again, groove angles may be different. Light Duty belts should not be used on heavy-duty drives.

The belt number C270 indicates a belt with a nominal 7/8" top width and a nominal length of 270". Its pitch length is 270.9". These should be ordered as: CP270 Classical belts. (The "P" is for Wood's Premium construction.)

The number 5VX1250 indicates a narrow belt with a nominal 5/8" top width and an effective outside length of 125". These belts should be ordered as follows: 5VX1250 Narrow belts. (The "X" identifies cogged construction belts.)

The number 4L550 indicates a Light Duty fractional horsepower belt having a nominal top width of 1/2" and a nominal outside length of 55". Light Duty belts are available for general purpose applications; specify 4L550 Light Duty. It is designed to have little or no stretch and will require few take-ups during its life.

Classical Belts

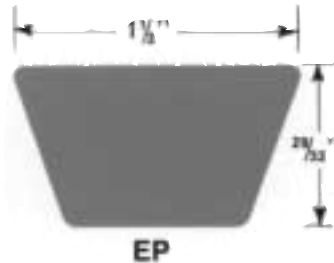
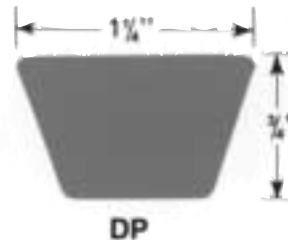
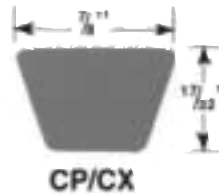
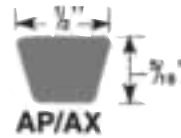

Narrow Belts

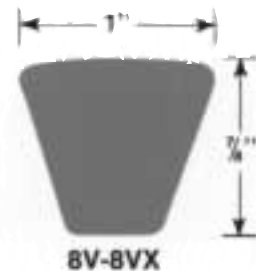

To assure maximum V-belt life, follow the minimum recommended pitch and sheave diameters for belts established by Mechanical Power Transmission Association and Rubber Manufacturers Association standards.

Classical Belt Section	Minimum* Pitch Diameter
A	3.0"
AX	2.2"
B	5.4"
BX	4.0"
C	9.0"
CX	6.8"
D	13.0"

**Not applicable to Light Duty Belts*

Narrow Belt Section	Minimum Sheave Diameter
3V	2.65"
3VX	2.2"
5V	7.1"
5VX	4.4"
8V	12.5"

All belts "ORS"

At one time it was necessary to order special belts for various types of environments. All Wood's belts are of "ORS" construction, meaning they are heat resistant, oil resistant and static conducting.

By heat resistant, we mean these belts will operate well in ambient temperatures up to 140°F. They may be operated at higher temperatures, but there would be a reduction in service life. In general, short belts develop higher internal temperatures than long belts. They are usually subjected to more flexures per minute and are frequently found on totally-enclosed drives where there is little or no air circulation.

Oil resistance is a matter of degree. It varies with the amount of contact with oil, whether it is continuous or intermittent immersion, exposure to an atmospheric mist or an occasional spattering. A great many chemicals, particularly petroleum derivatives, can cause deterioration. All Narrow, Classical and Light Duty belts will withstand nominal exposure to oil and grease, but they are not 100% oilproof.

For maximum performance from belts in oily atmospheres, they should be guarded as much as practical against excessive amounts of oil and should be periodically cleaned with methyl chloroform. Oil and grease on belts and sheaves will tend to lubricate the drive and reduce the traction of the belt, even though they may not actually harm the belts themselves. However, since the friction factor is reduced, belts must be operated at abnormal tensions, and their life is shortened.

Belt failure caused by oil is obvious and easy to detect. The most apparent sign is the build-up of a black, soft substance that can be wiped off when the belt is rubbed. Another sign is a softening and swelling of the belt to the point where it no longer fits the sheave groove properly.

Like oil resistance, resistance to ozone is a matter of degree. Narrow, Classical and Light Duty belts are resistant to normal amounts of ozone in the atmosphere. However, high concentrations such as found around arc welding equipment can cause rubber to harden and crack. It is because of ozone that belts should never be stored in direct sunlight.

Belts intended for operation in potentially dangerous atmospheres are constructed with a relatively low electrical resistance characteristic and referred to as "static conducting." All Narrow, Classical and Light Duty belts meet the following requirements.

In the standard method of measuring a belt's electrical resistivity, two 5/8"-diameter flat contacts are placed 8 1/2" apart on centers, moistened with water and pressed against the belt with a force of 12 1/2 lbs. The resistance "conductivity" between the contacts is measured with an ohmmeter operating at a potential of 500 volts and having an accuracy range from 0 to 10 megohms. Experience has demonstrated that the dissipation provided by belts having a resistance of 6 megohms or less "when new and measured as above" is satisfactory for operation in hazardous atmospheres.

Explosive atmospheres

Belts on drives in hazardous atmospheres should be kept reasonably free of encrusted accumula-



TB Wood's

tions of non-conducting materials. In addition, all elements of the drive must be interconnected and grounded to earth as illustrated here.

Although we know of no explosion caused by static generated by a V-belt drive, we cannot accept responsibility beyond that of furnishing belts within the above described limits.

Store belts properly

V-belts should be stored in a cool, dry place out of direct sunlight. They should be kept away from ozone-producing equipment such as arc welders and high voltage apparatus. Temperature should be below 85°F, relative humidity below 70%. If

belts are stored in piles, the piles should be kept small to avoid excessive weight which could distort the bottom belts. When belts are stored in boxes, the box size should be limited. Ideally, belts should be hung on saddle type pegs. With proper storage, belt quality will not change significantly within eight years.

Assuming good storage practices, a decrease in service life of approximately 10% per year of storage beyond eight years can be expected. From a norm of eight years storage life at 85°, it is estimated that the storage limit should be reduced by half for each 15° increase in temperature. A significant increase in humidity may cause a fungus to form on belts, but any effect on the performance of the belt would be very slight.

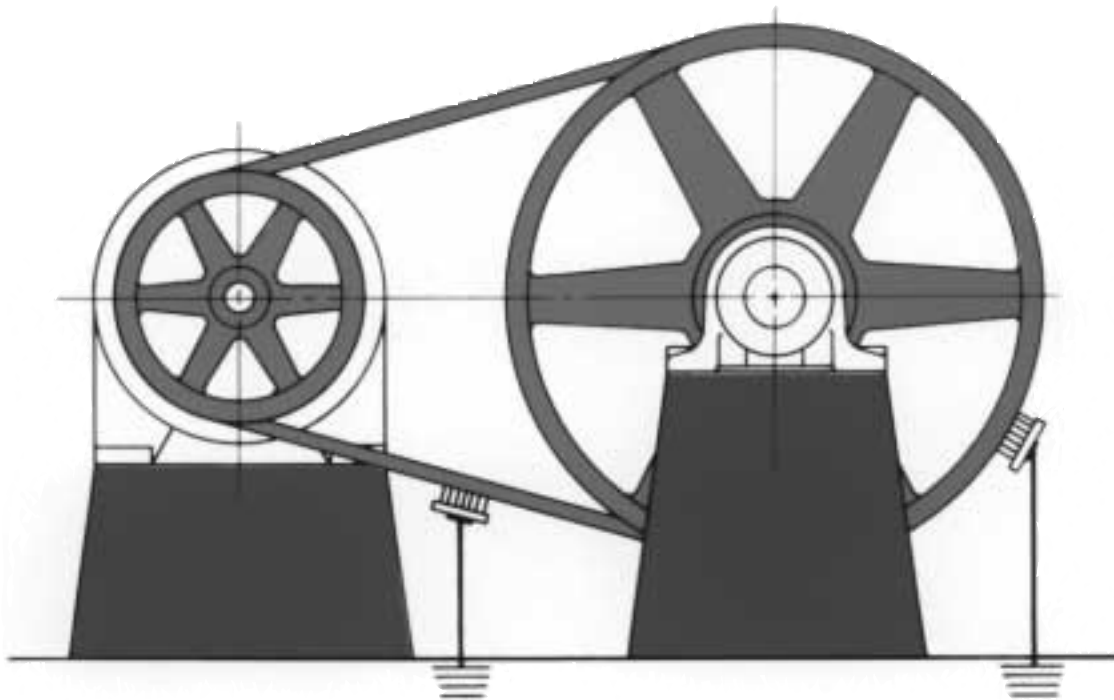

Proper V-drive installation in explosive atmospheres

Safety Tips

No matter where rotating machines are located or by what means they are driven, there is always a chance of personal injury unless they are installed and operated under safe conditions. It is with this thought uppermost in our minds that this manual is written.

Guard all drives properly

All regulating agencies such as OSHA, State Departments of Labor and Industry, insurance firms and other safety authorities either recommend or insist on drive guards. We, also, strongly recommend that every V-belt drive be completely guarded. Do not be lulled into a sense of security by a temporary or makeshift guard.

Of course, provision can and should be made for proper ventilation and inspection by the use of grills, inspection doors and removable panels. But the guard should have no gap where workers can reach inside and become caught in the drive. Besides being a safety asset, a good guard helps make maintenance easier by protecting the drive from weather and foreign objects.

Check safe speed limits

Safe speed limits for sheaves manufactured by TB Wood's Incorporated have been established by a rigorous burst testing program. The limit for cast iron sheaves has been established at 6500 fpm; the maximum speed in rpm corresponding to 6500 fpm is either cast or stamped on each sheave.

Before installing the drive, this safe speed limit should be checked against the speed of the shaft on which it is being installed. Operating sheaves above recommended speeds could result in serious damage to equipment and/or serious personal injury.

Safe speed is cast into the arm of Wood's sheaves.



Burst testing. Results of centrifugal force are clearly shown in these broken "D"-groove sheaves. The pattern of breakage is typical. The rim breaks away from the arms, arms break from hub and the hub shatters through its bolt holes. With the force in several hundred thousand pounds, it all happens in a split second.



Drive Installation

Sure-Grip® Sheave and Bushing Installation Instructions

Wood's Sure-Grip bushings are the most widely used, tapered, QD-type and have exceptional holding power that eliminates wobble. Standard and reverse mounting features provide greater

adaptability. Sure-Grip bushings can be used interchangeably in many of Wood's products as well as those of other manufacturers.

To Install:

IMPORTANT: DO NOT USE LUBRICANTS IN THIS INSTALLATION

Before beginning, make sure the correct size and quantity of parts are available for the installation. The bushing has been manufactured to accept a setscrew over the key and its use is optional. It is packaged with the hardware on sizes SH to M and loosely installed in the bushing on sizes N to S.

1. Inspect the tapered bore of the sheave and the tapered surface of the bushing. Any paint, dirt, oil, or grease **MUST** be removed.
2. Select the type of mounting (See Fig. 1 or 2) that best suits your application.
3. **STANDARD MOUNTING:** Install shaft key. (Note: If key was furnished with bushing, you must use that key.) Install bushing on clean shaft, flange end first. If bushing will not freely slide on the shaft, insert a screwdriver or similar object into the flange sawcut to act as a wedge to open the bushing's bore. **Caution: Excessive wedging will split the bushing.** If using the setscrew, tighten it just enough to prevent the bushing from sliding on the shaft. **Caution: Do not over tighten setscrew!** Slide sheave into position on bushing aligning the drilled holes in the sheave with the tapped holes in the bushing flange. (Note: Install M thru S bushings so that the two tapped holes in the sheave are located as far away as possible from the bushing's sawcut.) Loosely thread the capscrews with lockwashers into the assembly. **DO NOT USE LUBRICANT ON THE CAPSCREWS!**
4. **REVERSE MOUNTING:** With large end of the taper out, slide sheave onto shaft as far as possible. Install shaft key. (See shaft key note in #3

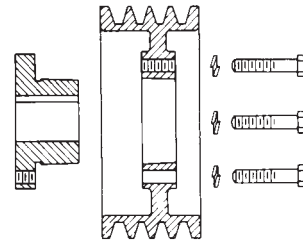

FIG. 1 Standard Mounting

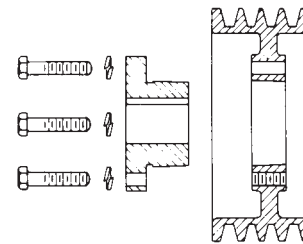

FIG. 2 Reverse Mounting

above.) Install bushing onto shaft so tapered end will mate with sheave. (See wedging note in #3 above.) If using the setscrew, tighten it enough to prevent the bushing from sliding on the shaft. **Caution: Do not over tighten setscrew!** Pull the sheave up on the bushing, aligning the drilled holes in the bushing flange with the tapped holes in the sheave. Loosely thread the capscrews with lockwashers into the assembly. **DO NOT USE LUBRICANT ON THE CAPSCREWS!**

5. Using a torque wrench, tighten all capscrews evenly and progressively in rotation to the torque value in Table. There must be a gap between the bushing flange and sheave hub when installation is complete. **DO NOT OVER TORQUE! DO NOT ATTEMPT TO CLOSE GAP BETWEEN BUSHING FLANGE AND SHEAVE HUB!**

To Remove:

1. Relieve drive tension by shortening the center distance between driver and driven sheaves.
2. Lift off belts.
3. Loosen and remove cap screws. If the bushings have keyway setscrews, loosen them.
4. As shown below, insert cap screws (three in JA through J bushings, two in QT and M thru W bushings and four in S bushing) in tapped removal holes and progressively tighten each one until mating part is loose on bushing. (Exception: If mating part is installed with cap screw heads next to motor, with insufficient room to insert screws in tapped holes, loosen cap screws and use wedge between bushing flange and mating part.)

5. Remove mating part from bushing, and if necessary, bushing from shaft.



Sure-Grip Bushing Screw Tightening Information

Tapered Bushing	Size & Thread of Cap Screw	Ft.-Lbs. To Apply With Torque Wrench
QT	1/4-20	9
JA	No. 10-24	5
SH-SDS-SD	1/4-20	9
SK	5/16-18	15
SF	3/8-16	30
E	1/2-13	60
F	9/16-12	110
J	5/8-11	135
M	3/4-10	225
N	7/8-9	300
P	1-8	450
W	1 1/8-7	600
S	1 1/4-7	750

CAUTION: The tightening force on the screws is multiplied many times by the wedging action of the tapered surface. If extreme tightening force is applied, or if a lubricant is used, bursting pressures will be created in the hub of the mating part.

Check alignment

Although alignment is not as critical in V-belt drives as in others, proper alignment is essential to long belt and sheave life.

First, make sure that drive shafts are parallel. The most common causes of misalignment are non-parallel shafts and improperly located sheaves.

Where shafts are not parallel, belts on one side are drawn tighter and pull more than their share of the load. As a result, these belts wear out faster, requiring the entire set to be replaced before it has given maximum service. If misalignment is in the sheave, belts will enter and leave the grooves at an angle, causing excessive belt cover and sheave wear.

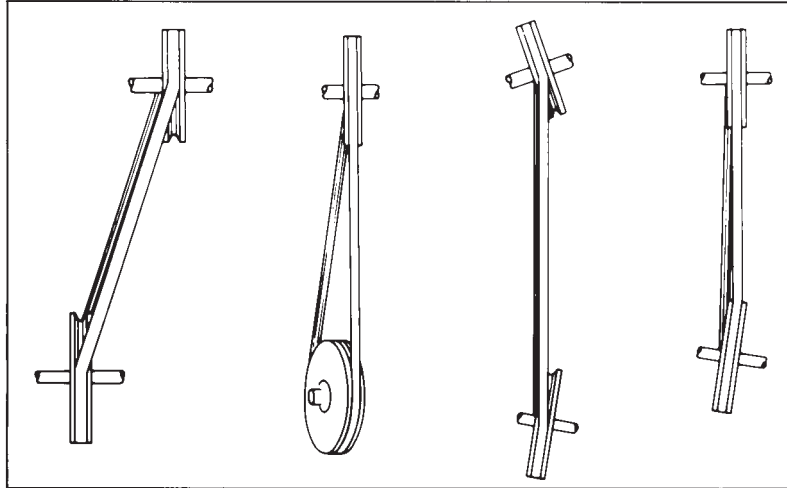

Shaft alignment can be checked by measuring the distance between the shafts at three or more locations. If the distances are equal, then the shafts will be parallel.

To check the location of the sheaves on the shafts, a straightedge or a piece of string can be used. If the sheaves are properly lined up, the string will touch them at the points indicated by the arrows in the accompanying sketch. Rotating

each sheave a half revolution will determine whether the sheave is wobbly or the drive shaft is bent. Correct any misalignment.

With sheaves aligned, tighten cap screws evenly and progressively. Apply the recommended torque to cap screws as listed in table on page 9. NOTE: There should be $\frac{1}{8}$ " to $\frac{1}{4}$ " gap between the mating part hub and the bushing flange. If gap is closed, the shaft is seriously undersize.

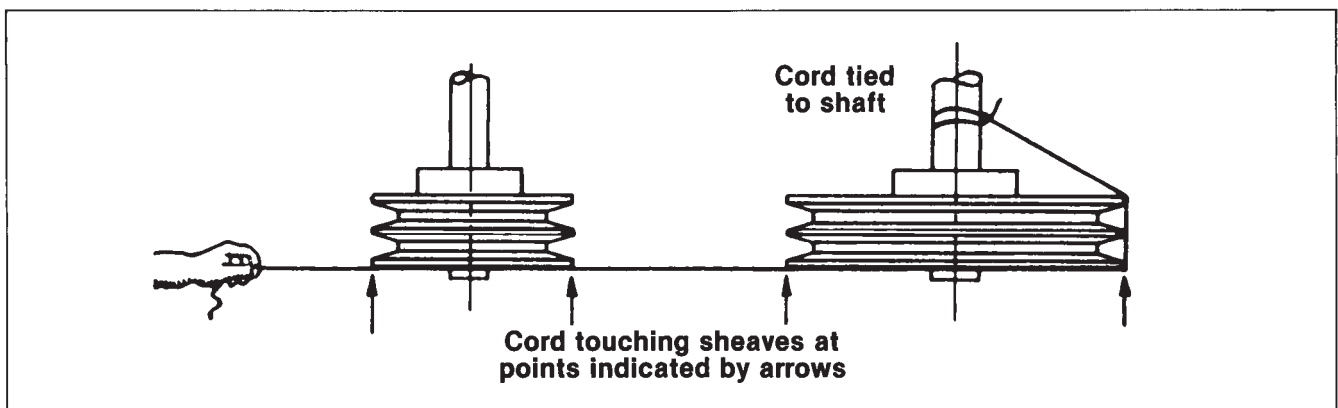

Install belts

Shorten the center distance between the driven and driver sheave so the belts can be put on without the use of force.

While the belts are still loose on the drive, rotate the drive until all the slack is on one side. Then increase the center distance until the belts are snug. The drive is now ready for tensioning.

NOTE: Never “roll” or “pry” the belts into the

sheave grooves. This can damage the belt cords and lead to belt turnover, short life or actual breakage. Moreover, it is both difficult and unsafe to install belts this way.

Keep take-up rails, motor base or other means of center distance adjustment free of dirt, rust and grit. Lubricate adjusting screws and slide rails from time to time.

No!



When belts are forced into the sheave with a screwdriver or other wedge, the outer fabric is often ruptured and cords broken.

Yes!



It is well worth the time to move the driver unit forward so V-belts can be slipped easily into the sheave groove without damage.

Center Distance Allowance for Installation and Take-Up (Inches)

Narrow Belts

Belt Length	For Installation (Subtract)						For take-up (Add)
	3VX & 3V	3V Banded	5VX & 5V	5V Banded	8VX & 8V	8V Banded	All Cross Sections
250 thru 475	0.5	1.2	–	–	–	–	1.0
500 thru 710	0.8	1.4	1.0	2.1	–	–	1.2
750 thru 1060	0.8	1.4	1.0	2.1	1.5	3.4	1.5
1120 thru 1250	0.8	1.4	1.0	2.1	1.5	3.4	1.8
1320 thru 1700	0.8	1.4	1.0	2.1	1.5	3.4	2.2
1800 thru 2000	–	–	1.0	2.1	1.8	3.6	2.5
2120 thru 2360	–	–	1.2	2.4	1.8	3.6	3.0
2500 thru 2650	–	–	1.2	2.4	1.8	3.6	3.2
2800 thru 3000	–	–	1.2	2.4	1.8	3.6	3.5
3150 thru 3550	–	–	1.2	2.4	2.0	4.0	4.0
3750	–	–	–	–	2.0	4.0	4.5
4000 thru 5000	–	–	–	–	2.0	4.0	5.5

Classical Belts

Belt Length Designation	For Installation (Subtract)							For take-up (Add)
	AX & AP	BX & BP	BX & BP Banded	CX & CP	CX & CP Banded	DX & DP	DX & DP Banded	All Cross Sections
21 thru 35	0.8	1.0	1.5	–	–	–	–	1.0
36 thru 55	0.8	1.0	1.5	1.5	2.0	–	–	1.5
56 thru 85	0.8	1.2	1.6	1.5	2.0	–	–	2.0
86 thru 112	1.0	1.2	1.6	1.5	2.0	–	–	2.5
116 thru 144	1.0	1.3	1.8	1.5	2.1	2.0	2.9	3.0
148 thru 180	–	1.3	1.8	2.0	2.2	2.0	3.0	3.5
191 thru 210	–	1.5	1.9	2.0	2.3	2.0	3.2	4.0
225 thru 240	–	1.5	2.0	2.0	2.5	2.5	3.2	4.5
255 thru 300	–	1.5	2.2	2.0	2.5	2.5	3.5	5.0
315 thru 390	–	–	–	2.0	2.7	2.5	3.6	6.0
420 and Over	–	–	–	2.5	2.9	3.0	4.1	1.5% of belt length.

All dimensions in inches.

Tensioning V-Belt Drives

Without exception, the most important factor in the successful operation of a V-belt drive is proper belt-tensioning. To achieve the long, trouble-free service associated with V-belt drives, belt tension must be sufficient to overcome slipping under maximum peak load. This could be either at start or during the work cycle. The amount of peak load will vary depending upon the character of the driven machine or drive system. To increase total tension, merely increase the center distance. Before attempting to tension any drive it is imperative that the sheaves be properly installed and aligned. If a V-belt slips it is too loose. Add to the tension by increasing the center distance. Never apply belt dressing as this will damage the belt and cause early failure.

General method

The general method for tensioning V-belts should satisfy most drive requirements.

Step 1: Reduce the center distance so that the belts may be placed over the sheaves and in the grooves without forcing them over the sides of the grooves. Arrange the belts so that both the top and bottom spans have about the same sag. Apply

tension to the belts by increasing the center distance until the belts are snug. See figure 1.

Step 2: Operate the drive a few minutes to seat the belts in the sheave grooves. Observe the operation of the drive under its highest load condition (usually starting). A slight bowing of the slack side of the drive indicates proper tension. If the slack side remains taut during the peak load, the drive is too tight. Excessive bowing or slippage indicates insufficient tension. If the belts squeal as the motor comes on or at some subsequent peak load, they are not tight enough to deliver the torque demanded by the drive machine. The drive should be stopped and the belts tightened.

Step 3: Check the tension on a new drive frequently during the first day by observing the slack side span. After a few days' operation the belts will seat themselves in the sheave grooves and it may become necessary to readjust so that the drive again shows a slight bow in the slack side.

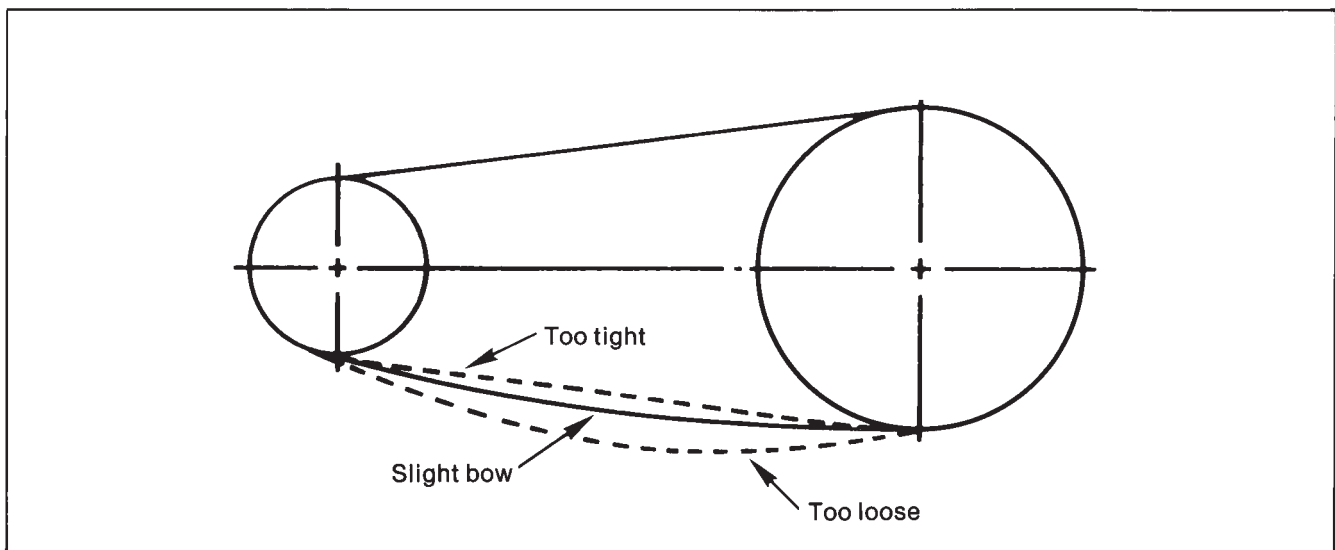

Figure 1

Force deflection method

This method should be used only for tensioning drives on which the grade of belt, rated belt capacity, service factor, design horsepower, etc. are known.

Step 1: Install belts per Step 1 of General Method. Measure span length (t) in inches as shown in figure 2, or calculate using formula.

Step 2: From figure 2 the deflection height (h) is always $\frac{1}{64}$ " per inch of span length (t). For example, a 32" span length would require a deflection of $\frac{32}{64}$ " or $\frac{1}{2}$ ".

Step 3: Determine the minimum, maximum, and initial recommended pounds force using table 1 or calculate based on the required Static Strand Tension (T_s). Note: The initial recommended force is used only for installing new belts which have not seated themselves into the sheave grooves and where initial belt stretch has not taken place.

Step 4: Using a spring scale, apply a perpendicular force to any ONE of the belts at the mid point of the span as shown in figure 2. Compare this deflection force with the values found in Step 3.

- a. If the deflection force is below the minimum, the belts are too loose and the tension should be increased by increasing the center distance.
- b. If the deflection force is higher than the maximum, the belts are too tight and the tension should be decreased.

When new V-belts are installed on a drive the INITIAL tension will drop rapidly during the first few hours. Check tension frequently during the first 24 hours of operation. Subsequent retensioning should fall between the minimum and maximum force.

To determine the deflection distance from normal position, use a straightedge or stretch a cord from sheave to sheave to use as a reference line. On multiple-belt drives an adjacent undeflected belt can be used as a reference.

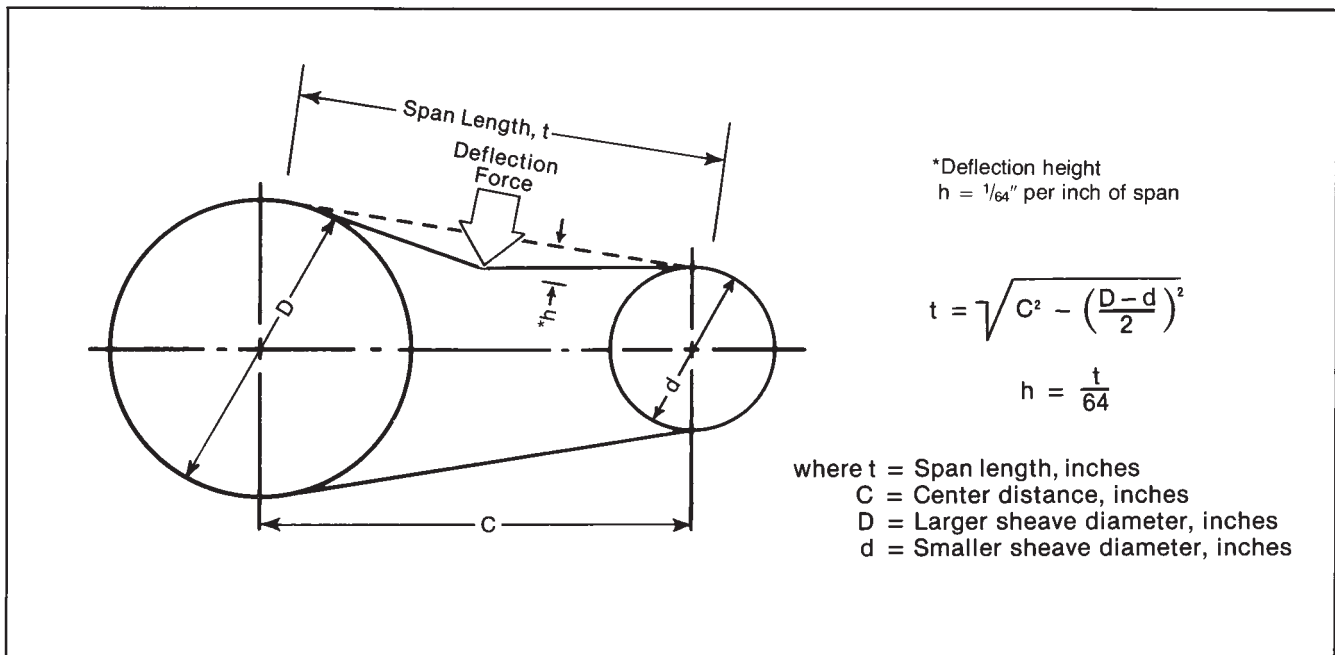

Figure 2

Table 1
Recommended Minimum Force Per Belt

Belt Section	Small Sheave		Drive Ratio			
	Speed Range	Dia.	1.0	1.5	2.0	4.0 & over
3V	1200-3600	2.65	2.0	2.4	2.6	3.0
	1200-3600	3.65	2.8	3.6	3.8	4.2
	1200-3600	4.75	3.8	4.2	4.4	4.8
	1200-3600	5.60	4.2	4.6	4.8	5.4
	1200-3600	6.90	4.6	5.0	5.2	5.6
5V	900-1800	7.1	8.5	9.5	10	11
	900-1800	9.0	10	11	12	13
	900-1800	14.0	12	13	14	15
	700-1200	21.2	14	15	16	17
8V	900-1800	12.5	18	21	23	25
	900-1800	14.0	21	23	24	28
	700-1500	17.0	24	26	28	30
	700-1200	21.2	28	30	32	34
	400-1000	24.8	31	32	34	36
3VX	1200-3600	2.20	2.2	2.5	2.7	3.0
	1200-3600	2.50	2.6	2.9	3.1	3.6
	1200-3600	3.00	3.1	3.5	3.7	4.2
	1200-3600	4.12	3.9	4.3	4.5	5.1
	1200-3600	5.30	4.6	4.9	5.1	5.7
	1200-3600	6.9	5.0	5.4	5.6	6.2
5VX	1200-3600	4.4	6.5	7.6	8.0	9.0
	1200-3600	5.2	8.0	9.0	9.5	10
	1200-3600	6.3	9.5	10	11	12
	1200-3600	7.1	10	11	12	13
	900-1800	9.0	12	13	14	15
900-1800	14.0	14	15	16	17	
AP	1800-3600	3.0	2.0	2.3	2.4	2.6
	1800-3600	4.0	2.6	2.8	3.0	3.3
	1800-3600	5.0	3.0	3.3	3.4	3.7
	1800-3600	7.0	3.5	3.7	3.8	4.3
BP	1200-1800	4.6	3.7	4.3	4.5	5.0
	1200-1800	5.0	4.1	4.6	4.8	5.6
	1200-1800	6.0	4.8	5.3	5.5	6.3
	1200-1800	8.0	5.7	6.2	6.4	7.2
CP	900-1800	7.0	6.5	7.0	8.0	9.0
	900-1800	9.0	8.0	9.0	10	11
	900-1800	12.0	10	11	12	13
	700-1500	16.0	12	13	13	14
DP	900-1500	12.0	13	15	16	17
	900-1500	15.0	16	18	19	21
	700-1200	18.0	19	21	22	24
	700-1200	22.0	22	23	24	26
AX	1800-3600	3.0	2.5	2.8	3.0	3.3
	1800-3600	4.0	3.3	3.6	3.8	4.2
	1800-3600	5.0	3.7	4.1	4.3	4.6
	1800-3600	7.0	4.3	4.6	4.8	5.3
BX	1200-1800	4.6	5.2	5.8	6.0	6.9
	1200-1800	5.0	5.4	6.0	6.3	7.1
	1200-1800	6.0	6.0	6.4	6.7	7.7
	1200-1800	8.0	6.6	7.1	7.5	8.2
CX	900-1800	7.0	10	11	12	13
	900-1800	9.0	11	12	13	14
	900-1800	12.0	12	13	13	14
	700-1500	16.0	13	14	14	15
DX	900-1500	12.0	16	18	19	20
	900-1500	15.0	19	21	22	24
	700-1200	18.0	22	24	25	27
	700-1200	22.0	25	27	28	30

MAXIMUM Deflection Force = Minimum times 1.5
INITIAL Deflection Force = Minimum times 2.0

Minimum deflection force values shown in table 1 are based on assumed average static tensions for drives having multiple belts or more than one V-band, thus eliminating calculations. (For drives using only one belt or one V-band, deflection force must be determined by use of engineering formulas.)

Find the minimum recommended deflection force for the belt section and type based upon the small sheave diameter, speed and drive ratio. For intermediate sheave diameters and/or drive ratio combinations the minimum deflection force may be interpolated.

For Narrow Band, Classical Band and Classical Cog Band belts multiply the minimum deflection force from table 1 by the number of belts in the band. Where larger values make use of the Force Deflection Method impractical, use the Elongation Method to tension V-bands.

Table 2
K Factors and Arc of Contact

D-d C	Arc Contact Degree	Factor		D-d C	Arc Contact Degree	Factor	
		Ac	K			Ac	K
0.000	180	1.000	24.750	0.750	136	0.879	30.411
0.025	179	0.997	24.883	0.775	134	0.874	30.688
0.050	177	0.994	25.019	0.800	133	0.869	30.975
0.075	176	0.990	25.158	0.825	131	0.864	31.270
0.100	174	0.987	25.300	0.850	130	0.858	31.576
0.125	173	0.983	25.444	0.875	128	0.852	31.892
0.150	171	0.980	25.591	0.900	127	0.847	32.219
0.175	170	0.977	25.742	0.925	125	0.841	32.558
0.200	169	0.973	25.896	0.950	123	0.835	32.909
0.225	167	0.969	26.053	0.975	122	0.829	33.273
0.250	166	0.966	26.213	1.000	120	0.823	33.652
0.275	164	0.962	26.377	1.025	118	0.816	34.045
0.300	163	0.958	26.545	1.050	117	0.810	34.454
0.325	161	0.954	26.717	1.075	115	0.803	34.879
0.350	160	0.951	26.892	1.100	113	0.796	35.323
0.375	158	0.947	27.072	1.125	112	0.789	35.786
0.400	157	0.943	27.257	1.150	110	0.782	36.270
0.425	155	0.939	27.445	1.175	108	0.774	36.777
0.450	154	0.935	27.639	1.200	106	0.767	37.307
0.475	153	0.930	27.837	1.225	104	0.759	37.864
0.500	151	0.926	28.040	1.250	103	0.751	38.448
0.525	150	0.922	28.249	1.275	101	0.742	39.064
0.550	148	0.917	28.463	1.300	99	0.734	39.713
0.575	147	0.913	28.684	1.325	97	0.725	40.398
0.600	145	0.908	28.910	1.350	95	0.716	41.123
0.625	144	0.904	29.142	1.375	93	0.706	41.892
0.650	142	0.899	29.381	1.400	91	0.697	42.709
0.675	141	0.894	29.627	1.425	89	0.687	43.580
0.700	139	0.889	29.881				
0.725	137	0.884	30.142				

Force deflection engineering formulas

For a more precise method, or where a V-drive combination is not within specified limits, table 1, use the following engineering formulas to determine force deflection values.

Step 1: Determine Span Length (t) and Deflection Height (h). Reference figure 2.

Step 2: Calculate the Static Strand Tension (Ts).

$$T_s = \frac{K \times DHP}{N \times S} + \frac{MS^2}{2}$$

Step 3: Calculate the recommended Deflection Forces (P) for drives using multiple belts or more than one V-band.

$$P_{\text{Minimum}} = \frac{T_s + Y}{16}$$

$$P_{\text{Maximum}} = \frac{1.5(T_s) + Y}{16}$$

$$P_{\text{Initial}} = 1.33 \text{ times } P_{\text{Maximum}}$$

Explanation of Symbols

A_c	= Arc of contact - smaller sheave, degrees
C	= Center distance, inches
D	= Larger sheave pitch diameter, inches
d	= Smaller sheave pitch diameter, inches
DHP	= Design horsepower based upon the recommended application service factor
h	= Deflection height, inches (Refer. figure 2)
K	= Value from table 2 depending on $\frac{D-d}{C}$ or $K = 16.5 \frac{2.5-A_c}{A_c}$
L	= Belt length, inches
M	= Centrifugal constant table 3
N	= Number of belts or V-band ribs
P	= Deflection force, pounds
S	= Belt speed, FPM/1000
t	= Span length, inches (Refer. figure 2)
Y	= Belt constant table 3

Note: For drives using only one belt or one V-band, and at least one shaft free to rotate use the following to determine the recommended Deflection Forces (P).

$$P_{\text{Minimum}} = \frac{T_s + Y \left(\frac{t}{L} \right)}{16}$$

$$P_{\text{Maximum}} = \frac{1.5(T_s) + Y \left(\frac{t}{L} \right)}{16}$$

$$P_{\text{Initial}} = 1.33 \text{ times } P_{\text{Maximum}}$$

**Table 3
Belt Constants M and Y**

Factors	Narrow			Narrow Cog		Classical					Classical Cog			
	3V	4V	8V	3VX	5VX	AP	BP	CP	DP	EP	AX	BX	CX	DX
M Single Belts	.46	1.23	3.28	.39	1.08	.66	1.08	1.98	3.74	5.85	.61	1.00	1.78	3.97
M V-Band	.51	1.32	3.80	—	—	—	1.40	2.33	4.29	6.26	—	1.28	2.10	4.56
Y	4.0	12.00	22.00	7.0	20.0	6.0	9.0	16.0	30.00	45.00	7.0	10.00	28.00	82.00

This method is recommended for V-band drives where larger deflecting forces make the use of previously described methods impractical.

Elongation is related to the tension causing it; thus, tape measured V-band lengths, both slack and tight, can be used to obtain proper V-band tension.

Step 1: Decrease the center distance until the V-band(s) can be easily slipped into the sheave grooves. Forcing the belts on can damage the load-carrying cords and cause premature belt failure.

Step 2: With the V-band(s) still on the drive at NO tension, measure the outside circumference (slack O.C.) of the bands. Note: If retensioning a used drive, decrease the center distance until there is no tension on the band(s), then measure the outside circumference (slack O.C.) of the band(s).

Step 3: Determine the required Static Tension (Ts) per individual rib strand using the following formula.

$$T_s = \frac{K \times DHP}{N \times S} + \frac{MS^2}{2}$$

Step 4: Find a range of recommended tensions.

Lower Tension = Ts

Upper Tension = 1.5 times Ts

Step 5: Calculate minimum and maximum elongated band lengths for use in tensioning the drive.

- a. From table 4, find length multipliers corresponding to the lower and upper Ts values in Step 4 above.
 - b. Multiply the slack O.C. found in Step 2 by the length multipliers to find the minimum and maximum elongated band lengths.
-

Step 6: Increase the drive center distance until a tape measurement of the band(s) O.C. is between the two values calculated for elongated band length Step 5b.

Step 7: Retension as required. New V-bands may lose tension rapidly during the run-in period and will probably require retensioning. V-bands that have been on a drive for some time may also require retensioning due to tension decay from normal use and wear.

**Table 4 Belt length multipliers
for tensioning banded belts**

Ts Per Strand (lbs.)	NARROW BAND				CLASSICAL BAND				CLASSICAL COG BAND				
	CROSS SECTION												
	3V	5V		8V		BP		CP		DP	BX All Sizes	CX All Sizes	DX All Sizes
5V1700 & under		5V1800 & over	8V1700 & under	8V1800 & over	BP144 & under	Over BP144	CP144 & under	Over CP144					
10	1.00186	1.00056	1.00001	1.00013	1.00010	1.00113	1.00141	1.00029	1.00052	1.00013	1.00082	1.00027	1.00013
12	1.00220	1.00068	1.00097	1.00016	1.00012	1.00135	1.00168	1.00035	1.00062	1.00016	1.00098	1.00032	1.00016
14	1.00254	1.00079	1.00113	1.00019	1.00014	1.00157	1.00194	1.00041	1.00072	1.00019	1.00114	1.00038	1.00019
16	1.00288	1.00090	1.00129	1.00021	1.00016	1.00178	1.00220	1.00046	1.00082	1.00021	1.00129	1.00043	1.00021
18	1.00320	1.00101	1.00144	1.00024	1.00018	1.00199	1.00246	1.00052	1.00092	1.00024	1.00145	1.00048	1.00024
20	1.00352	1.00112	1.00159	1.00027	1.00020	1.00220	1.00271	1.00058	1.00102	1.00027	1.00160	1.00054	1.00027
24	1.00414	1.00133	1.00190	1.00032	1.00024	1.00261	1.00320	1.00069	1.00122	1.00033	1.00191	1.00065	1.00032
28	1.00472	1.00155	1.00219	1.00037	1.00029	1.00301	1.00368	1.00081	1.00141	1.00038	1.00220	1.00075	1.00038
32	1.00520	1.00176	1.00249	1.00043	1.00033	1.00339	1.00414	1.00092	1.00161	1.00044	1.00250	1.00086	1.00043
36	1.00556	1.00197	1.00277	1.00048	1.00037	1.00377	1.00458	1.00104	1.00180	1.00050	1.00278	1.00097	1.00049
40	1.00588	1.00217	1.00305	1.00054	1.00042	1.00413	1.00500	1.00115	1.00199	1.00056	1.00306	1.00107	1.00054
45	1.00625	1.00243	1.00340	1.00060	1.00047	1.00458	1.00529	1.00129	1.00222	1.00063	1.00341	1.00121	1.00061
50	1.00659	1.00268	1.00374	1.00067	1.00053	1.00500	1.00553	1.00144	1.00246	1.00071	1.00374	1.00134	1.00068
55	1.00691	1.00293	1.00406	1.00074	1.00058	1.00528	1.00574	1.00158	1.00268	1.00078	1.00407	1.00147	1.00075
60	1.00722	1.00317	1.00438	1.00081	1.00064	1.00553	1.00591	1.00172	1.00291	1.00086	1.00439	1.00161	1.00081
65	1.00754	1.00341	1.00470	1.00088	1.00070	1.00576	1.00606	1.00186	1.00313	1.00094	1.00470	1.00174	1.00088
70	1.00787	1.00365	1.00500	1.00095	1.00076	1.00596	1.00620	1.00200	1.00335	1.00102	1.00500	1.00187	1.00095
75	1.00822	1.00389	1.00523	1.00101	1.00082	1.00614	1.00632	1.00214	1.00357	1.00110	1.00522	1.00200	1.00102
80	1.00861	1.00412	1.00545	1.00108	1.00088	1.00631	1.00644	1.00228	1.00378	1.00118	1.00543	1.00213	1.00109
85	1.00903	1.00434	1.00566	1.00115	1.00094	1.00646	1.00656	1.00242	1.00399	1.00127	1.00563	1.00227	1.00116
90	1.00949	1.00456	1.00586	1.00122	1.00100	1.00659	1.00668	1.00256	1.00420	1.00135	1.00581	1.00240	1.00123
95	1.01000	1.00478	1.00606	1.00129	1.00106	1.00672	1.00682	1.00270	1.00441	1.00144	1.00599	1.00253	1.00130
100	1.01056	1.00500	1.00625	1.00136	1.00113	1.00684	1.00697	1.00284	1.00461	1.00152	1.00616	1.00266	1.00137
120	1.01333	1.00561	1.00696	1.00164	1.00139	1.00727	1.00780	1.00339	1.00528	1.00188	1.00679	1.00319	1.00166
140	1.01692	1.00617	1.00765	1.00192	1.00166	1.00771	1.00912	1.00393	1.00579	1.00226	1.00736	1.00371	1.00195
160	1.02081	1.00672	1.00836	1.00220	1.00194	1.00827	1.01104	1.00447	1.00627	1.00265	1.00793	1.00423	1.00224
180	1.02385	1.00728	1.00913	1.00249	1.00223	1.00902	1.01357	1.00500	1.00675	1.00306	1.00854	1.00474	1.00253
200	1.02655	1.00707	1.01000	1.00277	1.00254	1.01000	1.01718	1.00534	1.00724	1.00349	1.00922	1.00525	1.00283
240	1.03118	1.00921	1.01213	1.00335	1.00319	1.01279	1.02268	1.00607	1.00832	1.00440	1.01090	1.00625	1.00343
280	1.03579	1.01088	1.01524	1.00395	1.00389	1.01663	1.02737	1.00692	1.00963	1.00542	1.01313	1.00724	1.00405
320	1.04070	1.01292	1.01834	1.00454	1.00461	1.02088	1.03275	1.00797	1.01124	1.00656	1.01590	1.00824	1.00468
360	1.04671	1.01562	1.02162	1.00515	1.00543	1.02423	1.03853	1.00926	1.01317	1.00771	1.01925	1.00924	1.00532
400	1.05308	1.01826	1.02526	1.00575	1.00631	1.02708	1.04393	1.01081	1.01580	1.00886	1.02229	1.01026	1.00598
450		1.02179	1.03056	1.00652	1.00744	1.03072	1.05000	1.01311	1.01877	1.01028	1.02625	1.01156	1.00683
500		1.02558	1.03643	1.00732	1.00859	1.03425		1.01610	1.02186	1.01164	1.03000	1.01292	1.00768
550		1.02927	1.04200	1.00813	1.00976	1.03781		1.01888	1.02500	1.01293	1.03354	1.01435	1.00856
600		1.03286	1.04642	1.00896	1.01094	1.04158		1.02169	1.02813	1.01413	1.03685	1.01557	1.00946
650		1.03632	1.05000	1.00982	1.01213	1.04567		1.02449	1.03123	1.01524	1.04000	1.01729	1.01037
700		1.03967		1.01071	1.01331	1.05000		1.02718	1.03426	1.01625	1.04333	1.01919	1.01130
750		1.04310		1.01163	1.01449			1.03000	1.03719	1.01718	1.04667	1.02126	1.01224
800		1.04655		1.01257	1.01571			1.03282	1.04000	1.01802	1.05000	1.02372	1.01320
850		1.05000		1.01354	1.01689			1.03563	1.04268	1.01833		1.02607	1.01418
900				1.01454	1.01887			1.03838	1.04524	1.01936		1.02840	1.01518
950				1.01561	1.01927			1.04101	1.04768	1.02044		1.03068	1.01619
1000				1.01667	1.02049			1.04345	1.05000	1.02156		1.03209	1.01717

Trouble Shooting V-Belts

How to spot V-belt trouble

Trouble	Cause	To correct
Belt slip (sidewalls glazed)	Not enough tension.	Replace belts; apply proper tension.
Drive squeals	Shock load. Not enough arc of contact. Heavy starting load.	Apply proper tension. Increase center distance. Increase tension.
Belt turned over.	Broken cord caused by prying on sheave. Overloaded drive. Impulse loads. Misalignment of sheave and shaft. Worn sheave grooves. Flat idler sheave. Excessive belt vibration.	Replace set of belts correctly. Redesign drive. Apply proper tension. Realign drive. Replace sheaves. Align idler. Re-position on slack side of drive close to drive sheave. Check drive design. Check equipment for solid mounting. Consider use of banded belts.
Mismatched belts.	New belts installed with old belts. Sheave grooves worn unevenly; improper groove angle. Give appearance of mismatched belts. Sheave shafts not parallel. Give appearance of mismatched belts.	Replace belts in matched set only. Replace sheaves. Align drive.
Belt breaks.	Shock loads. Heavy starting loads. Belt pried over sheaves. Foreign objects in drive.	Apply proper tension; Recheck drive. Apply proper tension; Recheck drive. Use compensator starting. Replace set of belts correctly. Provide drive shroud.
Belt wears rapidly.	Sheave grooves worn. Sheave diameter too small. Mismatched belts. Drive overloaded. Belt slips. Sheaves misaligned. Oil or heat condition.	Replace sheaves. Redesign drive. Replace with matched belts. Redesign drive. Increase tension. Align sheaves. Eliminate oil. Ventilate drive.

How to diagnose V-belt failure

V-Belt Troubleshooting Checklist

BELT CONDITION

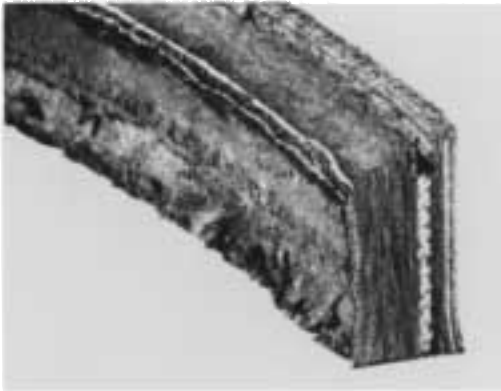

Oil Deterioration

CAUSE

Oil-softened rubber.

PREVENTION

Splash guards will protect drives against oil. Although Classical belts are oil resisting, excessive oil can cause some deterioration.



Cover Fabric Rupture

CAUSE

Cover fabric ruptured when belt was pried over sheave during installation.

PREVENTION

Proper installation of belts by moving motor so belts do not have to be pried into the grooves.

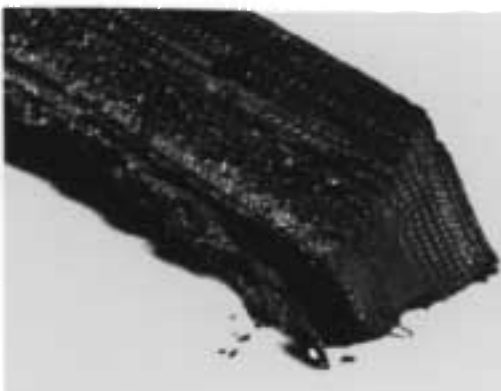

Slip Burn

CAUSE

Belt too loose. Belt didn't move, friction against sheave burned rubber. When belt finally grabbed, it snapped.

PREVENTION

Maintain proper tension on the drive.

How to diagnose V-belt failure

V-Belt Troubleshooting Checklist

BELT CONDITION



Base Cracking

CAUSE

Severe back-bend idlers. Improper storage. Excessive ambient operating temperature.

PREVENTION

Check storage conditions. If back-bend idler cannot be avoided, install idler of larger diameter. Avoid ambient temperature over 140°.

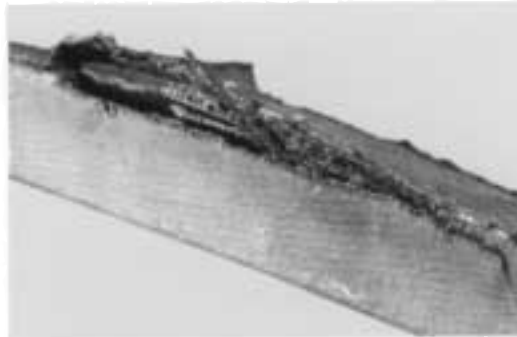

Ply Separation

CAUSE

Split along pitch line indicating belt ran over too small a sheave.

PREVENTION

Redesign drive using sheaves of proper size.

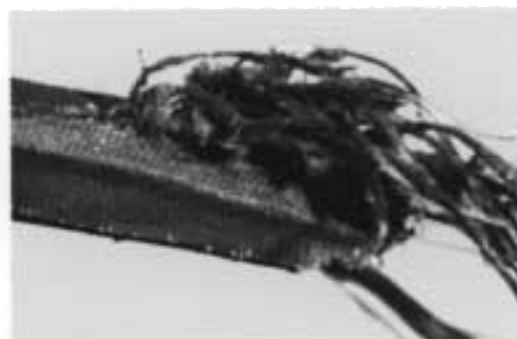

Ruptured

CAUSE

Ruptured cords in the plies.

PREVENTION

Check for rocks or tools falling into sheave grooves. Check tension. Belts loose enough to twist in groove can rupture cords.

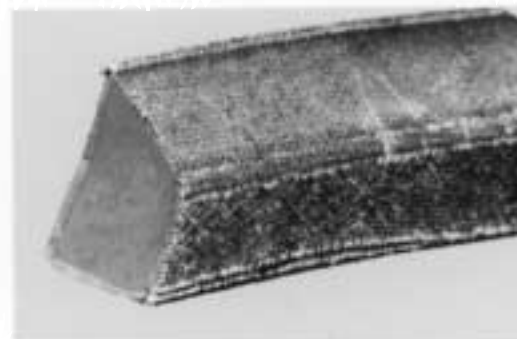

Worn Belt Sides

CAUSE

Misalignment. Grit or dirt. Normal wear.

PREVENTION

Align sheaves. Replace belts as required.

How to diagnose V-belt failure

V-Belt Troubleshooting Checklist

BELT CONDITION



Snub Break

CAUSE

Cover wear indicates slip. Clean break reveals sudden snap.

PREVENTION

Maintain proper tension on the drive.



Distorted Belt

CAUSE

Breakdown of adhesion or broken cords.

PREVENTION

Do not pry belts on drives. Check sheaves for recommended diameters.

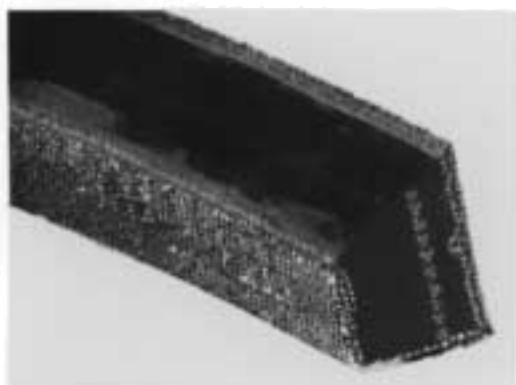

Abrasion

CAUSE

Foreign material and rust in sheaves wore away sidewalls, letting belt drop to bottom of groove.

PREVENTION

Dust guards help protect against abrasion. Tension must be maintained in dusty atmospheres.

SURE-GRIP® SHEAVE FEATURES



Wood's sheaves are constructed of fine grain, high tensile cast iron, and have been carefully engineered to assure maximum performance over a long life span. Behind each sheave is one of the most extensive engineering design and testing programs in the industry.

DESIGN INTEGRITY

TB Wood's Incorporated has been a leading supplier of cast iron pulleys, v-belt sheaves, synchronous belt sprockets and Sure-Grip mounting bushings since the inception of these products. We are committed to the continual improvement of our standard products and special or MTO products through design, materials and quality enhancements. For example, new product designs are typically computer generated and then verified using finite element analysis before CAD drawings are made. This enables Wood's to quickly and accurately quote on any special needs, and to relay the tool paths for new designs quickly from engineering to the shop floor.

FOUNDRY PROCESSES

TB Wood's Incorporated has a modern state-of-the-art foundry in Chambersburg, PA where cast iron and ductile iron castings are produced. This captive foundry operation not only gives Wood's the control needed to obtain standard high quality castings as they are required, but also enables them to produce any special requirements in a minimal amount of time.

MACHINING

TB Wood's Incorporated has numerous machining facilities throughout North America. Each is equipped with modern CNC equipment and capable of doing high precision machining. Statistical process controls are in place in each location, and each has been ISO-9000 certified.

SPECIFICATIONS

TB Wood's products are manufactured to conform to or exceed recognized industry standard specifications. The following is a listing of some of these specs.

ANSI/RMA	IP-20	Classical V-Belt Sheaves
ANSI/RMA	IP-22	Narrow V-Belt Sheaves
ANSI/RMA	IP-24	Synchronous Sprockets
MPTA	QD-1	QD Bushing Guideline
MPTA	SPB	Pulley Balance
MPTA	SAS	V-Belt Sheave Arm Stress
MPTA	SF	Pulley Surface Finish

Altra Industrial Motion

Warner Electric

Electromagnetic Clutches and Brakes - USA

South Beloit, IL
815-389-3771

For application assistance:
1-800-825-9050

Electromagnetic Clutches and Brakes - Europe

St Barthelemy d'Anjou, France
+33 (0)2 41 21 24 24

For sales office:
+33 (0)2 41 21 24 76

Precision Electric Coils and Electromagnetic Clutches and Brakes - USA

Columbia City, IN
260-244-6183

Inertia Dynamics

Spring Set Brakes; Power On and Wrap Spring Clutch/Brakes

Torrington, CT
860-482-4444

Matrix International

Electromagnetic Clutches and Brakes, Pressure Operated Clutches and Brakes

Brechin, Scotland
+44 (0) 1356 602000

U.S.
815-389-3771

Warner Linear

Linear Actuators and Guideways - USA

Belvidere, IL
815-547-1106

For application assistance:
1-800-825-9050

TB Wood's

V-Belt Drives, Synchronous Drives, Flexible Couplings, Variable Frequency AC Drives

Chambersburg, PA
717-264-7161

For assistance:
1-888-829-6637
Press #5 – Customer Service
Press #7 – Mechanical Applications
Press #8 – Electronic Applications

Wichita Clutch and Industrial Clutch

Pneumatic and Oil Immersed Clutches and Brakes - USA

Wichita Falls, TX
940-723-3400

Pneumatic Clutches and Brakes - Europe

Bedford, England
+44 (0)1234 350311

Twiflex Limited

Caliper Brakes and Thrusters

Twickenham, England
+44 (0) 20 8894 1161

Formsprag Clutch

Overrunning Clutches and Holdbacks

Warren, MI
586-758-5000

For application assistance:
1-800-927-3262

Marland Clutch

Roller Ramp and Sprag Type Overrunning Clutches and Backstops

Burr Ridge, IL
630-455-1752

Stieber Clutch

Overrunning Clutches and Holdbacks

Heidelberg, Germany
+49 (0)6221 30 47 0

Boston Gear

Enclosed and Open Gearing, Electrical and Mechanical P.T. Components

Charlotte, NC
704-688-7300
For customer service:
1-800-825-6544

For application assistance:
1-800-816-5608

Huco Dynatork

Precision Couplings and Air Motors

Hertford, England
+44 (0) 1992 501900

U.S.
800-825-6544

Ameridrives Couplings

Gear Couplings, Mill Spindles, Universal Joints

Erie, PA
814-480-5000

Bibby Transmissions

Disc, Gear, Grid Couplings, Overload Clutches

Dewsbury, England
+44 (0) 1924 460801

Nuttall Gear and Delroyd Worm Gear

Worm Gear and Helical Speed Reducers

Niagara Falls, NY
716-298-4100

Saftek Friction

Non-asbestos Brake and Clutch Materials

Telford, England
+44 (0) 1952 581122

Altra Industrial Motion - Asia Pacific and Africa

China	852 2615 9313
Taiwan	886 2 2577 8156
Singapore	65 6487 4464
Thailand	66 2 322 5527
Australia	612 9894 0133
S. Africa	27 11 918 4270



An Altra Industrial Motion Company

TB Wood's Incorporated

440 North Fifth Avenue • Chambersburg, PA 17201
Tel: 888-TBWOODS • 717-264-7161
Fax: 717-264-6420
www.tbwoods.com